

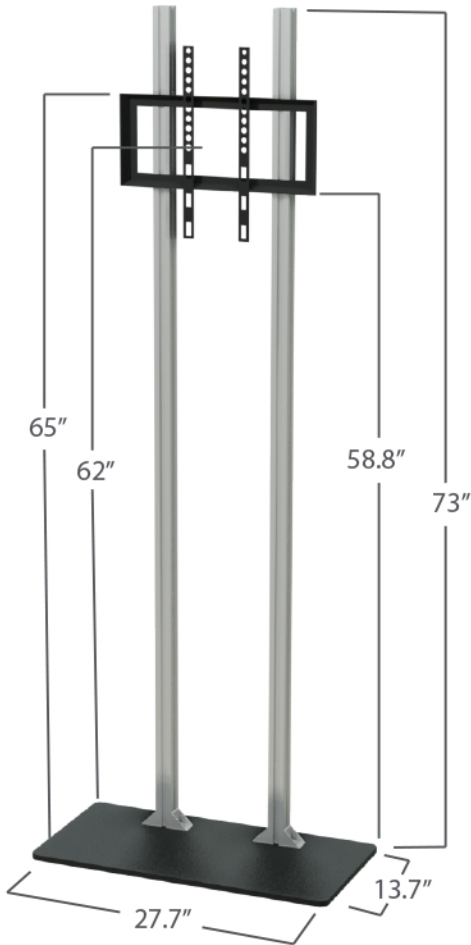

Large Monitor Mount Setup WLM-Mount-L



Description

Designed to fit any Waveline Display, these mounts achieve a "floating" screen experience. Simply slide the mount behind the display, and attach your screen on the front. Graphics can include a cut-out for easy access, or you can do your own cut as needed. Kit includes wooden base plate, aluminum post and mount.









Dimensions

Product Weight: 21lbs	Shipping Weight: 24lbs
Assembled Size: 27.5"w x 73"h x 13.7"d	Box Dimensions: 39" x 15" x 5"

Monitor Specifications

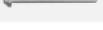
Holds Monitors up to 55" or 50 lbs
Up to VESA 400x400

Parts

- A - x10 M8 Allen Screw 
- B - x8 Flat Gasket 
- C - x4 M8 Nut 
- D - x4 M8 Philips screw & Gasket 
- E - x2 M5 Philips Screw 
- F - x4 Bracket-to-Monitor Screws: M5, M6, & M8 screws included. Check your TV for specs 
- G - x4 L-Bracket & Cap 
- Allen Keys 
- Philips Screwdriver 



Monitor Brackets x2



Monitor Plate



Vertical Poles x4



Base



Carry Bag

*Note: Please check all pockets in the carry bag for parts.

Large Monitor Mount Setup

WLM-Mount-L

Lay poles on the floor and match the stickers together. You should see two perforations in the front of each of the top sections.

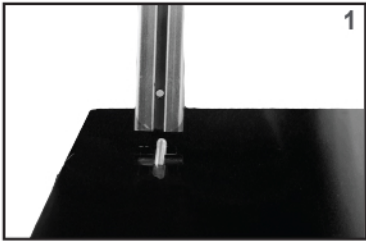
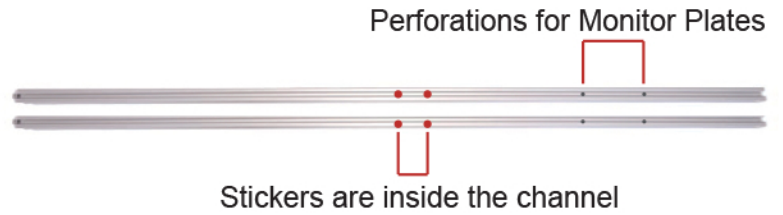

Secure each of the lower sections of the poles to the base with screw **A**.

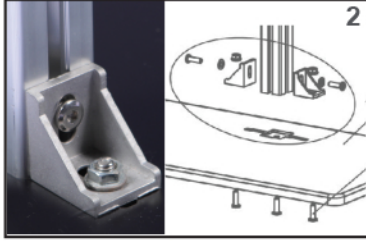

Attach the triangular supports to sides of poles, using **A** screws, **B** gasket and **C** nuts.

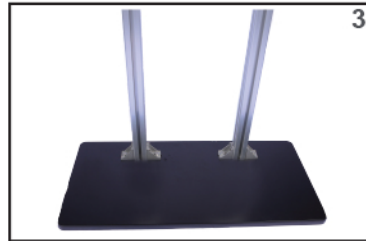

Secure screws with Allen wrench

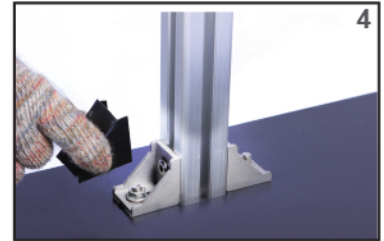

Attach caps to triangular supports

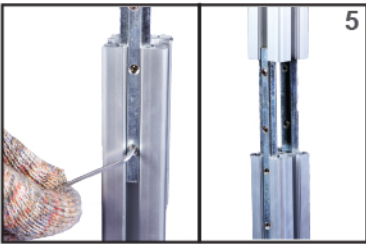

Connect the pole extension using allen key to secure connector insert



Attach the Mount Plate to the pole, use (4) Philips **D** screw



Place the Monitor Stand behind your display, slide the base forward

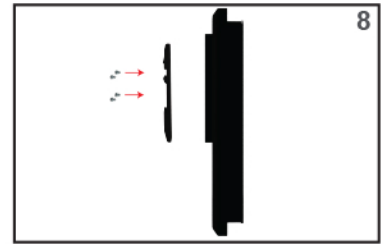

Mount the brackets to the back of the monitor with 4 **F** screws

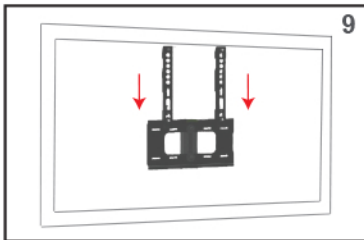

Slowly hang the Bracket onto the Monitor Plate through the opening on the graphic

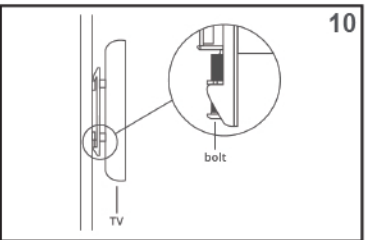

Secure the bracket to the Monitor Plate by tightening the safety screws **E**



Enjoy your display!